



Pro AV Golf Electric Series

Electric/Motorized Golf Simulation Projector Screen

User's Guide – EN Type (RC1)

V1

Visit www.eliteproav.com for the latest updated version

Product Description

The ProAV Golf Electric is an innovative retractable impact screen that utilizes Elite's SWAPTEXTM technology, which allows the user to quickly replace the impact screen material should the need arise.

Important Safety & Warning Precautions

Make sure to read this user's guide and follow the procedure below.

SCREEN MAINTAINANCE

Dust, dirt and scratches on the projection screen surface will affect the quality and performance of the projection image. For optimal results we advise to pay attention to the following instructions.

1. Materials needed: Two Lint-Free white cloths, Mild Soap (hand soap is suitable) and Water.
2. Take the Lint-Free cloth and submerge it in warm water for cleaning light dust and dirt. For stubborn stains or a sticky surface, a solution of hand soap diluted with warm water should be used.
3. Completely ring out cloth so it is lightly dampened, not drenched.
4. Using the damp cloth, lightly wipe in an up and down motion starting at the left of the screen moving to the right of the screen. **DO NOT WIPE IN CIRCULAR MOTION.**
5. Once you have completed wiping the entire screen with a dampened Lint-Free cloth, use the dry Lint-Free cloth to wipe off any excess water from the screen

Notes: The following precautions should be followed to avoid damaging the material, which is not covered under warranty.

- Don't scratch the material, as it will leave permanent markings on the screen's surface.
- Don't point to the screen material with a fingertip or other sharp objects to prevent damage to the material.
- Don't use acetone, benzene, alcohol and any other organic solvents to clean the screen material. Using such chemicals will permanently damage the screen.

Please retain this user's guide for future reference.

- To avoid damaging the unit, do not use with any unauthorized accessories not recommended by the manufacturer.
- Handle the unit carefully during transportation to avoid any damages.
- To ensure safe and reliable operation, direct connection to a properly grounded power source is advised.
- The power outlet supplying power to the unit should be close to the unit and easily accessible.
- Do not install the unit on uneven or inclined surfaces.
- Do not put heavy objects on the power cord and position it properly to avoid creating a trip obstacle.
- Never overload the power cord to prevent an electric shock or fire due to a loose contact or a short circuit.
- There are not user serviceable parts in this unit. Do not attempt to disassemble this unit by yourself. No one except authorized technicians can open and make repairs to this unit.
- Make sure the power source this unit is connected to has a continuous power flow.
- If there is need to use an extension cord, make sure the cord has an equal rating as the appliance to avoid overheating.
- Do not handle the power plug when your hands are wet or your feet are in contact with water.

Do not use this unit under the following circumstances.

- Disconnect the power cord under the conditions of heavy rain, wind, thunder or lightning.
- Avoid direct Sunshine, rain shower and moisture.
- Keep away from fire sources and high temperature to prevent this device from overheating.
- Cut off the power supply first before transportation or maintenance.
- Fully disconnect from the power supply when the unit is not in use for a long period of time, as should be done with any other electric household appliance.
- To avoid possible injury and/or an electric shock, do not attempt to use the screen if there is obvious damage or if there are any evident broken parts.

NOTE: This equipment has been tested and found to comply with the limits for a Class B digital device, pursuant to Part 15 of the FCC Rules.

These limits are designed to provide reasonable protection against harmful interference in a residential installation. This equipment generates and can radiate radio frequency energy and, if not installed and used in accordance with the instructions, may cause harmful interference to radio communications.

However, there is no guarantee that the interference will not occur on a particular installation. If this equipment causes harmful interference to radio or television reception, which can be determined by turning the equipment off and on, the user is encouraged to try to correct the interference by one or more of the following measures.

- ✓ **Reorient or relocate the receiving antenna of the device which may be causing the interference.**
- ✓ **Increase the separation between the screen and the device's receiver.**
- ✓ **Connect the equipment into a different power outlet other than the device.**

Pre-Installation

1. Carefully unpack the screen.
2. Always handle the screen in a leveled position on a clean surface.
3. In order to protect the screen from exposure to stains, keep the screen out of contact with foreign particles such as dust, sawdust, and/or liquids.

SCREEN MATERIAL DISCLAIMER

At first, the screen material may have a series of noticeable horizontal lines on its surface. These are known as memory lines. Memory lines are caused when the pliable projection material is rolled up and stored for the duration between its production and sale. This is both a normal and correctable phenomenon. For non-tensioned screens, you may also notice curling along the edges of the material. This is mainly due to environments in cold temperatures. Please try the following to alleviate the memory lines and side curls on the material. After installation, leave the screen in the down position for a few days in a warm room environment (above 75 degrees) and then commence regular (up/down) usage. This allows the material to stretch out and cure itself. After a few days, the lines should vanish and the edge curling will alleviate and will neither return nor affect the projected image during the years of its use.

Please read this notice carefully before installation

Wall screws included with this product are complimentary and may not be adequate for all mounting surfaces. Consult with a professional installer or hardware store for proper mounting screws and anchors.

Regardless of the mounting method, the screen should be securely supported so that the vibration or pulling on the viewing surface will not cause the screen case to become loose or fall. The installer must ensure that the proper mounting hardware and the fasteners used are of adequate strength and suitable for the mounting surface.

Parts list

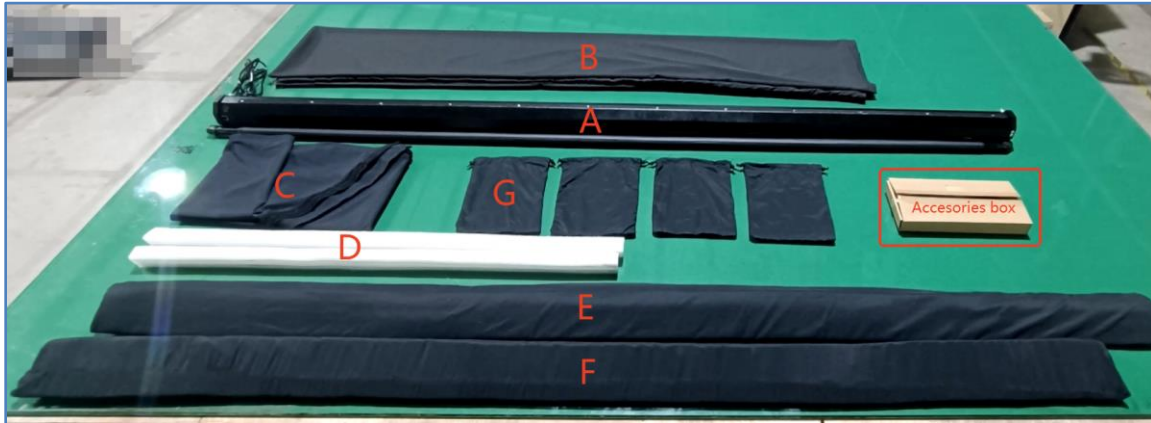

A	Electric screen	B	Back and side enclosure cover
C	Top enclosure cover	D	Extended foam (With adhesive backing)
E	Front protective foam	F	Bottom bar protective foam
G	Sandbag x 4		
Inside the accessory box			
H	12" L bracket (with carabiner) x 2	I	RF remote
J	Wall Box	K	RJ50 Cable
M	Hardware Kit		

Basic step of installation:

Bracket mounting > Electric screen hanging > enclosure cover installation

L bracket installation

1. Using Hardware kit (M) from accessory box, attach the eye bolt to the front end of the bracket, using a washer and wing nut on the top, and a washer and hex nut on the bottom to secure it tightly. (as shown in the picture)



2. Instructions for mounting bracket (H) to the wall/ceiling.

- ① Drill hole.
- ② Insert flangeless anchor into predrilled hole.
- ③ Place bracket into predrilled hole.
- ④ Insert pan head Phillips screw into pre-drilled hole for bracket mounting.

※ Please ensure that the bracket is fixed at a position not exceeding 3 meters.

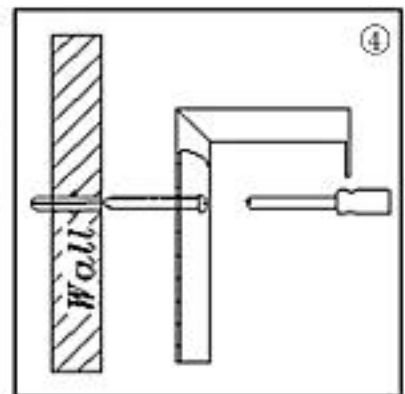
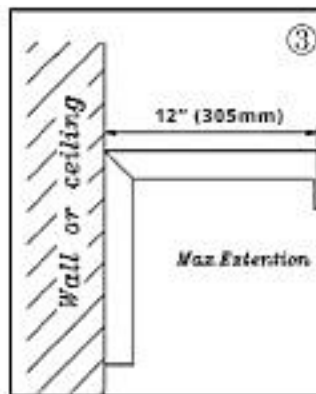
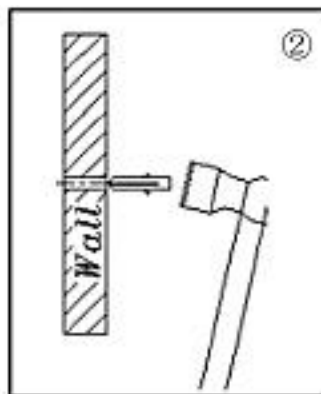
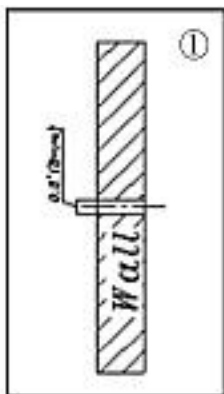

Electric screen setup

3. Flip the Electric screen (A) to the back, and attach the Extended foam (D) to the back of the casing using adhesive.

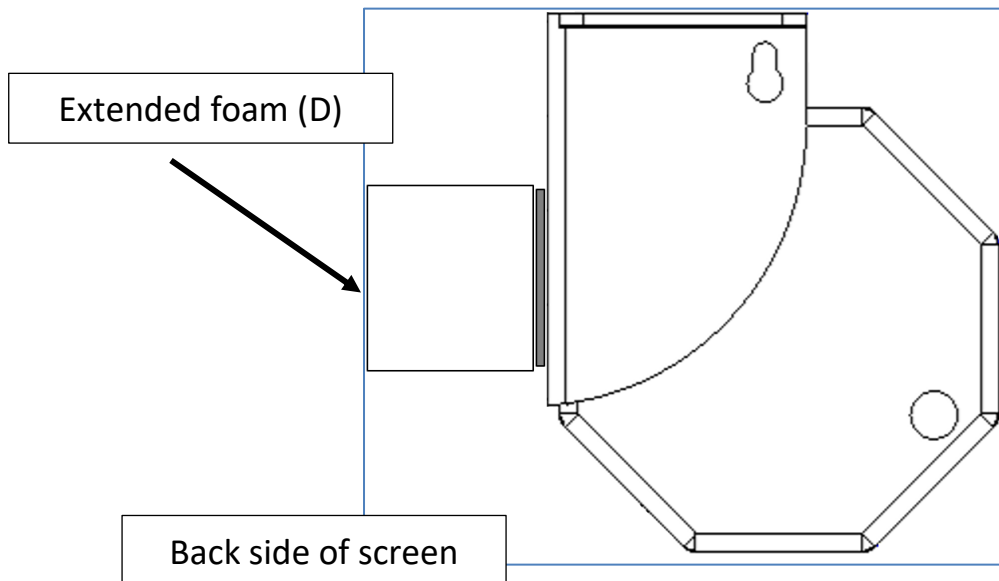

4. Take the carabiner from Hardware kit (M) and attach it to the hanging hole on Electric screen (A).
※ Please notice the hole is on the center of the screen end cap, not the hole at the tail ends.

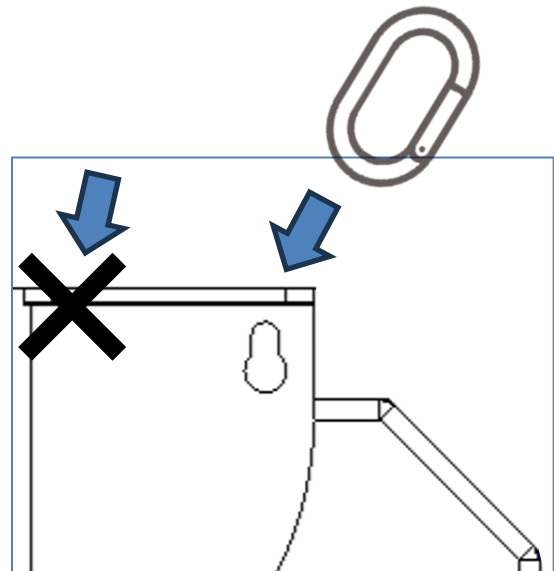

5. Two people work together to hang the Electric screen (A) on to the carabiner of the L bracket (H).



6. Use an M10 wrench (not included) to loosen the upper extend rod of Electric screen (A), turn it out and fix it, and secure the rope to the upper eyebolt of the bracket in a triangular structure.

Note: The angle of the rope can be adjusted by adjusting the position of the knot.



Installation of enclosure cover / protective foam

7. Take the Back and side enclosure cover (B) and attach it to the Electric Screen (A), try to attach inside the extend rods (do the same for another side), and attach the Electric screen to the back with covering rear Extended foam (D) with Velcro.

Noted: Please note the fixed direction of the Velcro fasteners.



8. Attach Top enclosure cover (C) to the back of Electric screen (A) with Velcro, then pull it flat and attach it to the outer sides of the two upper extended rods.



9. Attach the Front protective foam (E) to the Velcro strap on the front of the Electric screen (A).



Setting up the impact screen (Sandbag configuration + Tensioning method)

10. Filling sandbags (G)

※ A full sandbag weighs approximately 5 kg.



11. Connect the Electric screen with power source, then use RF remote control (I) to drop the impact material.

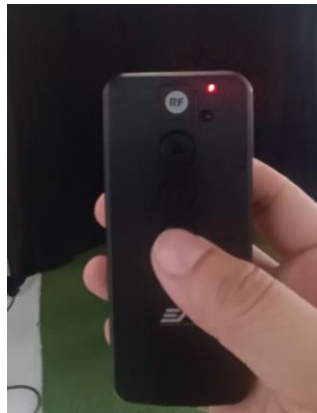

12. When the impact screen drops to the ground, attach the Bottom bar protective foam (F) to the weight bar Velcro area.



13. Continue to drop the screen until the material is loose, then secure the weight bar and the corners of the Back and side enclosure cover on both sides to the ground using sandbags (G)

※ The weight bar should be at $\frac{2}{3}$ the depth of the sandbags.

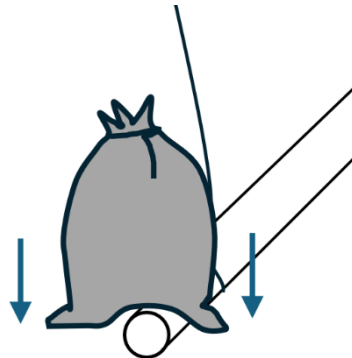

14. Slightly raise the screen until the material is tightened and stop the screen to keep the material is flatness.

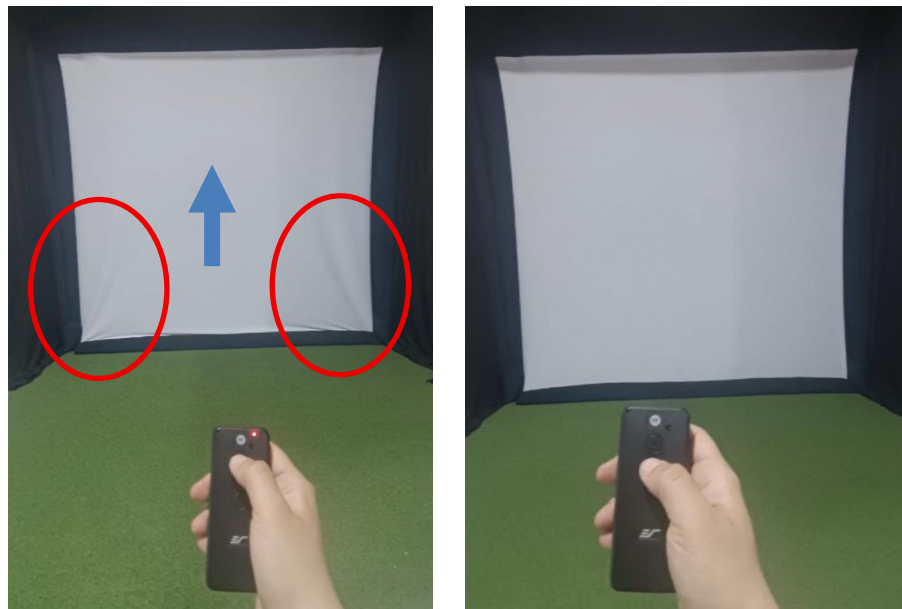

15. Now please enjoy the full golf hitting experience.



Precautions for using ProAV Golf Electric screen

The ImpactWhite 250 uses elastic fabric, which is relatively easy to deform by external forces.

Please retract the screen into the housing when not in use.

The screen is elastic and will stretch over time, causing the riser limit to drop. This is normal; simply adjust the riser limit position.

The screen must be kept a certain distance from the back and side enclosure cover to achieve optimal shock absorption.

How to fix wrinkles in an ImpactWhite screen material



1. Remove the weight bar sandbags.

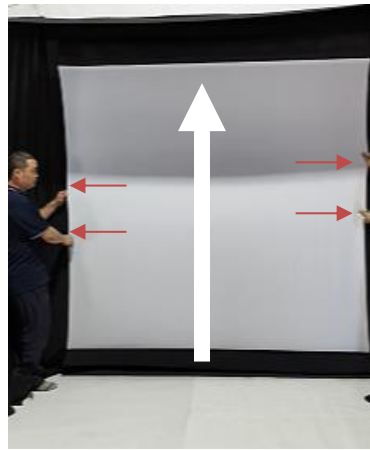

2. Two people work together to gently pull the screen taut to the left and right.
※ Please make sure that the material is flat while it roll back into the tube.

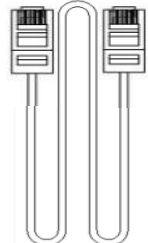

3. Use the remote control to smoothly retract the screen into its casing, but still pull the material at both side into flat status.※
4. After the screen is fully roll back and left to stand for a few hours, it can be put back up for use.

ProAV Golf Electric Series Controls and Accessories		
A. RF Remote ZRC1-RF	B. Wall box controller ZRC1-WB	C. RJ50 cable ZRC1-RJ50
		

Screen operation

Electric voltage: 100V ~ 110v.

1. After ensuring the power outlet & screen are compatible (voltage), plug the power cord into the power outlet.
2. Once the screen has power, you'll be able to control it using any of the 5 methods described below.
3. Remote controller requires AAA batteries (not included).

4 Ways to control the screen

1. RF Remote Control (Item B): The radio waves eliminate the need for a direct line of sight and has a longer distance control range.

The RF remote is already pre-synced/paired and ready to use. If synchronization/ pairing is needed, please follow the steps below.

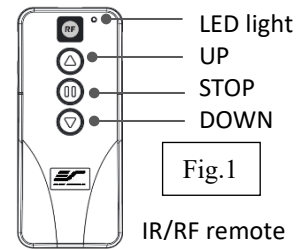

Fig.1

How to synchronize/pair a new RF remote:

- Press & hold the “**Programming Key**”, then press the “**Up Key**” on the **Wall box controller** (wall-box LED flashes). *Reference the wall box controller section for programming key location.*
- Then press the “**Up Key**” on the **RF remote**.
- The **Wall box** LED will flash 5 times, to indicate the RF remote has been properly synchronized/paired.

How to change the RF code (For use when multiple screens/RF remotes are owned, Fig.2)

Changing the RF code avoids controlling multiple screens at the same time and prevents electrical interference leading to accidental control of the screen.

1. Remove the batteries
2. Change the RF code switch
3. Insert the batteries
4. Synchronize it with the wall box controller

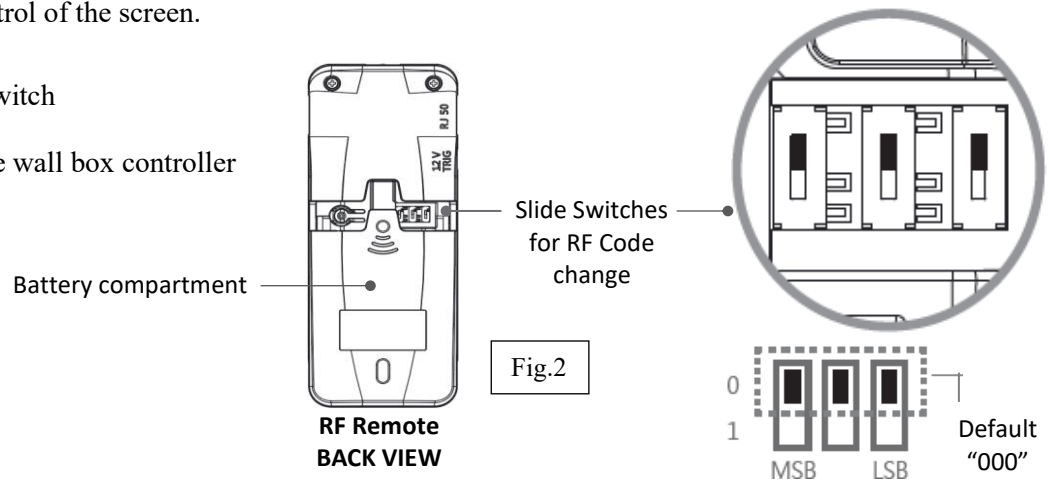

Fig.2

2. Wall box controller (Item C, Fig.3): The wall box controller switch is a wall mounted control box with an up/stop/down button. It plugs directly into the screen’s RJ50 port.

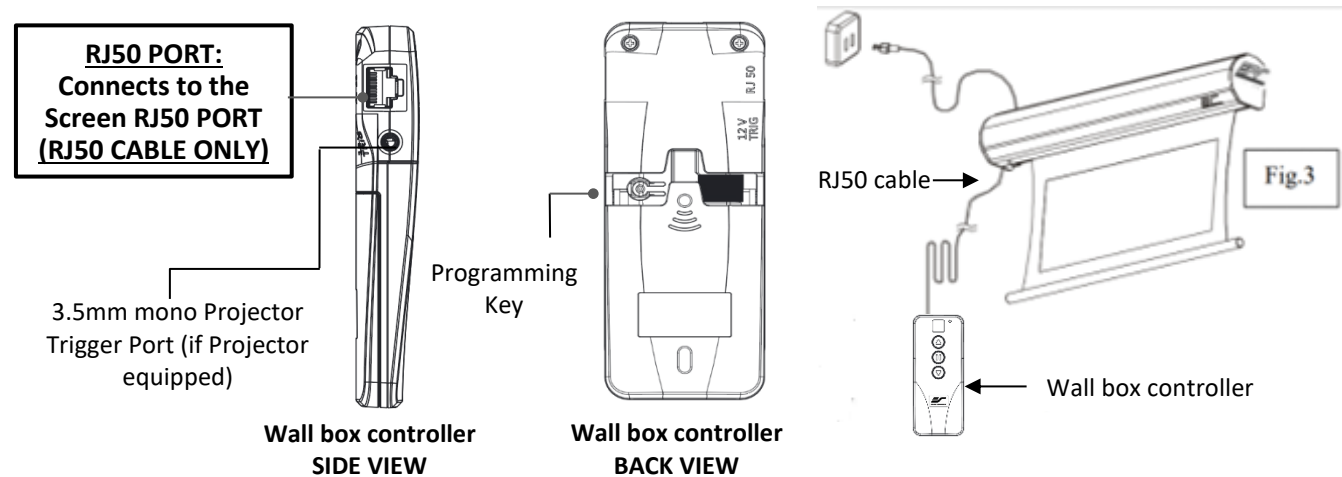

Fig.3

3. Wired 5-12 volt trigger: Requires a 3.5mm to 3.5mm mono cable (not included)

Step 1: Connect one end the RJ50 cable to the screen and the other end to the Wall box controller.

Step 2: Then connect one end the 3.5mm mono cable to the wall box controller and the other to the projector.

Once the two cables have been connected, the wired trigger feature is ready to synchronize the screen's up/down operation with the projector's power cycle.

- Projector on, screen drops
- Projector off, screen raises

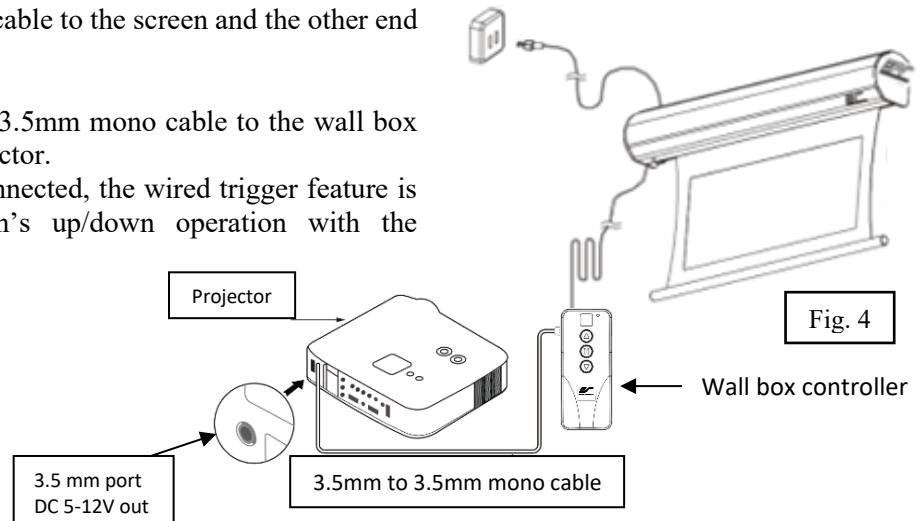

4. Wireless 5-12 volt trigger (Fig 5): Requires a 3.5mm to 3.5mm mono cable (Not included).

The Radio Frequency (RF) remote control serves as a dual purpose, independently as a handheld remote control, or as a Wireless 5-12 volt trigger. The radio frequency technology sends a wireless signal that synchronizes the screen's drop & rise with the projector's power cycle.

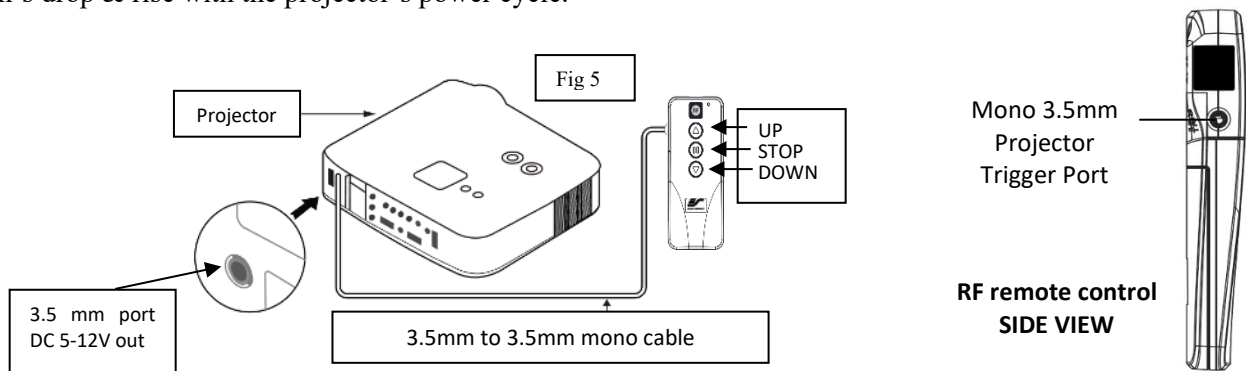

Here's how to set up your Wireless 5-12 volt trigger

The 5-12V wireless trigger should already be synced and ready to work.

Step1: Connect one end of the 3.5 mm mono trigger cable to the RF remote. 

Step 2: Connect the other 3.5 mm mono end of the cable to your projector 

Step 3: Turn on the projector and the screen should automatically deploy.

Step 4: Turn off your projector and the screen should automatically retract.

(Please be aware, the projector on/off cycle may take longer to fully activate. It usually takes around 20-30seconds for full off and on cycle each time)

Note: If the wireless trigger feature does not work, please resync the RF remote to the Wall box controller per the instructions in the Radio Frequency remote section.

ADVANCED Programming Key Instructions: (FOR ADVANCED USERS ONLY)

Wall box controller must be connected to the screen.

ATTENTION: Reducing the factory's full screen drop may produce waves/wrinkles on the projection surface on tab-tension screens. The full drop is recommended to allow the screen to rely on the tab-tension system to maintain the projection surface flat and taut on all sides.

The same applies on non-tensioned screens, although some level of waves may be present due to the nature of the screen not being tensioned. If wrinkles/waves develop after making the adjustment to the desired drop position, reset it to the factory's default position per the instructions below.

FLATNESS AFFECTED BY NEW PROGRAMMED VERTICAL POSITION IS NOT COVERED UNDER A REPLACEMENT WARRANTY.

1. Preset the Screen's Drop Position:

Use the RF/IR remote or Wall Box Controller to Drop the screen to the desired position you want to set it at. Press & hold the "**Programming Key**", then press the "**Down key**" on the Wall Box Controller. The LED will flash 5 times to confirm new programmed drop position.

PROGRAMMING NOTE:

The programmed vertical position relies on a time-count which adjusts itself according to the programmed timed difference. Multiple up/down programming will result in the vertical position being off a few inches. It is recommended that programming is done the **first-time** the desired vertical position is determined or RESET it to factory default and programming the desired vertical position afterwards.

2. Clear/Reset the Screen's Drop Position to factory default:

Press & hold the "**Programming Key** + "**Stop key**" on the wall box controller.

DIRECT SUNLIGHT DISCLAIMER

Projection Screens from any maker are not designed for use as a window curtain and should never be exposed to direct sunlight. Prolonged exposure to solar radiation will destroy synthetic materials and such damage is not covered by our standard warranty.

See examples below.

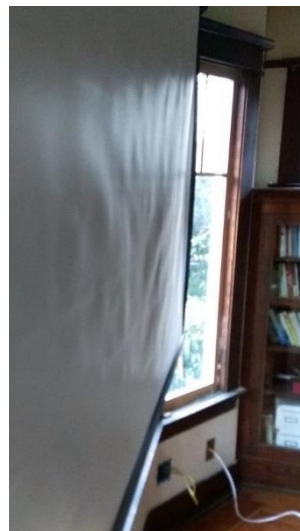

SHORT THROW PROJECTION DISCLAIMER

Using a **short throw projector** on a **non-tensioned** type screen will result in image distortion as the slightest wave on the viewing surface will become more evident.

For **short throw projectors**, Elite ProAV recommends the use of a **motorized tab-tensioned, fixed frame or whiteboard** projection screen.

Examples of undoctored projection images using a standard throw and short-throw projector

Standard throw projected image shown below (waves are not visible)

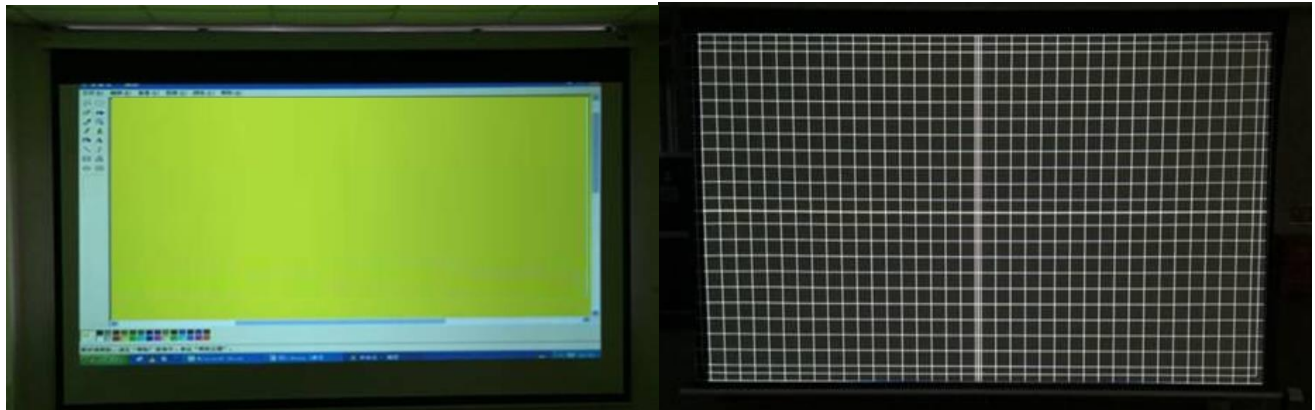

This **short throw** projected image shown below, demonstrates how waves on the surface become more pronounced:

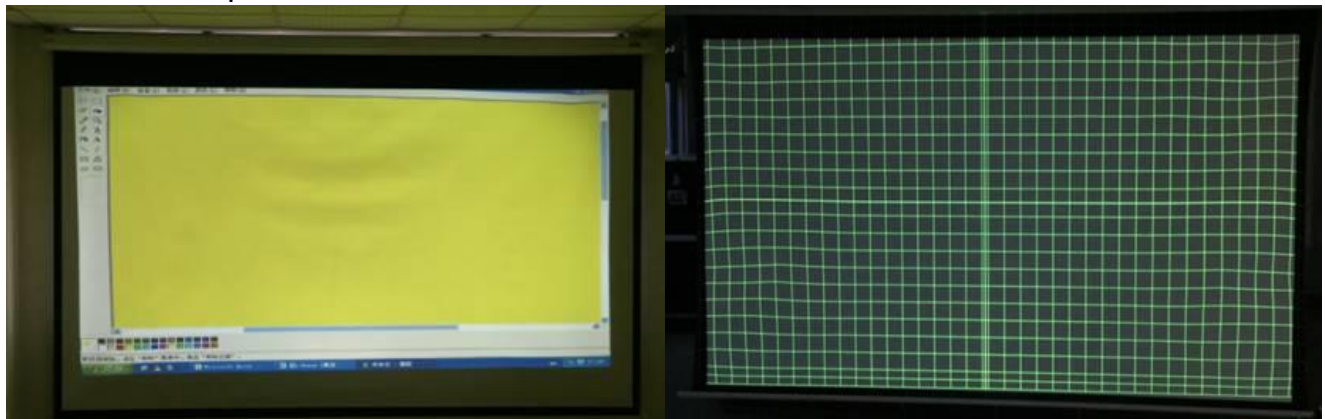

Actual Projection Images by two different Elite ProAV model with **Standard Throw Projector** (Model #:ViewSonic Pro8300) vs. **Short Throw Projector** (Model #:BenQW710ST)

For more information, technical support or your local Elite ProAV contact, please visit www.eliteproav.com