



Insta-DE2a/2aF Series

Self-Adhesive Dry-Erase Front Projection Screen Film with Frame Border and Pen Tray

User's Guide

Thank you for choosing the Insta-DE2a Series dry-erase whiteboard projection screen! Please read through this user guide before utilizing the screen. Correct usage and maintenance will ensure a long product life.

Precautionary Notes:

Before using the dry-erase function of your whiteboard screen, please make note of the following instructions to properly maintain and clean your dry-erase surface projection screen. (These Whiteboard cleaning tips are just as relevant with any dry-erase writing surface as they are with our Whiteboard-Projection Screens.)

1. Only use a high density foam eraser when removing dry-erase markings from the Whiteboard screen.
2. Do not use abrasive erasers as these may scratch the surface of the screen.
3. Never spray the whiteboard cleaner solution onto the surface while marker writing is present and then attempt to use a high density foam eraser to remove. This will only smear the dry-erase marker ink making the surface more difficult to clean and will likely ruin the foam eraser.
4. If there are any dry-erase markings left behind even after attempting to remove them using our high density erasers, spray our whiteboard cleaning solution directly onto the screen surface and use only a soft microfiber cloth to wipe-down and clean the area.

For a video demonstration, please visit: <http://www.elitescreens.com/whiteboardscreen-cleaning>

If replacement cleaning accessories are needed, please visit the Whiteboard cleaning accessories section of our website at <http://www.elitescreens.com/clean-whiteboard>

Product Features

- Anti-reflection surface reduces glare and hot-spot while using a projector.
- Special anti-scratch layer to ensure long use as a dry-erase/projection screen.
- 1.1 gain with 180 degree wide viewing angle.
- Award winning and GREENGUARD certified VersaWhite material.



Application Advantages

- Instantly converts flat surfaces/walls into a dry-erase whiteboard projection screen.
- Includes adhesive black velveteen border to enhance contrast and overall appearance.
- Perfect dry-erase and projection solution for today's short throw projectors
- Ideal and effective instructional presentation tool in the classroom, boardroom, and training facilities.

For a full installation demonstration, please see our Insta-DE 2aF Installation Video

Installation Video

Watch our installation video on-line at www.elitescreens.com/ide2afinstall or scan the QR code



Product Specifications

Specifications:	
Color display	White
Thickness	2.1mm
Material composition	High molecular weight copolymer of Terephthalic acid ethyl esters
Weight	377g/m ²
Temperature	At room temperature
Gain	1.1
Viewing Angle	180°

What's in the package

Please make sure all parts listed below are included.

Notes: For best results and maximum product longevity, **ONLY** use a high density whiteboard eraser.

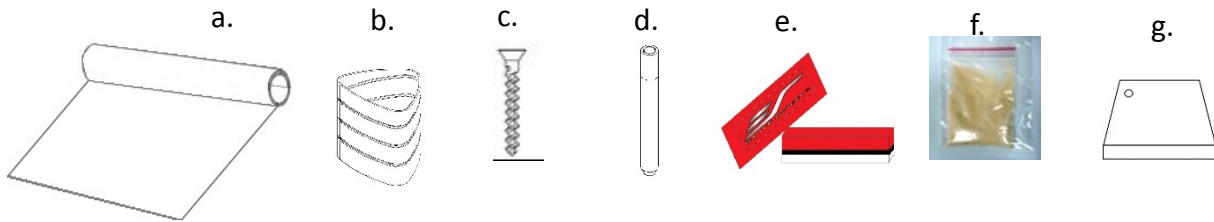

Parts List	QTY
a. Insta-DE2a Screen Material Film Roll	1
b. Pen Holder (Self-stick cradle)	1
c. 4.5mmx30mm screw	1
d. Whiteboard markers (pens)	2
e. High density eraser	1
f. Glue powder bag	See table
g. Scraper (smoothing tool)	1

Model Number	Powder bag qty
iWB114XW2aF	1
iWB5x10W2aF	1
iWB5x20W2aF	2

Frame and Pen Tray Parts List

Frame Parts Qty	Part A Qty	Part B Qty
iWB114XW2aF	2	4
iWB5x10W2aF	2	6
iWB5x20W2aF	2	10

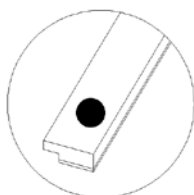



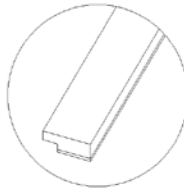



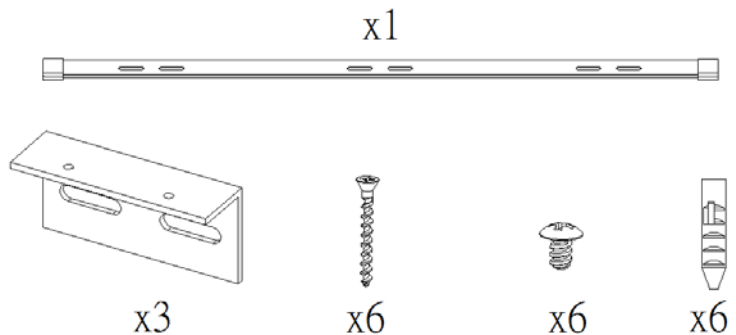



*Part A



*Part B



Tools required (not included)

Carpenter's Pencil	Tape Measurer	Sponge	150 grit sandpaper	Roller cover and frame	Level
					
Paint Tray	Dust Mask	Safety goggles	Painting tape	Acrylic based Primer	Strainer
					
Whisk	Measuring cup	Small bucket	Scraper	Step Stool/Ladder	
					

Preparing the installation surface:

The *Insta-DE 2a* product is to be solely installed on a flat Level 5 surface. The dry erase function of this product requires a smooth writeable surface. The smoother the surface, the better the result of the finished product will be.

Any surfaces that are textured (ex. orange peel, drilled holes, glue/tape residue, dents, etc.) should be patched, sanded, and primed before applying the *Insta-DE2a* screen. We recommend sanding the area first to make sure you have a clean flat and smooth surface. Failure to remove such imperfections can damage the product.

EliteProAV is not responsible should these instructions are not properly followed.

The warranty of this product will be voided if any bubbling occurs due to the use of an after-market spray adhesive or if the screen was applied on to a textured wall.

Before applying the Insta-DE 2a, the application surface must be dry, clean, smooth, and structurally sound.

1. Clean the surface to remove any dirt, grease, and wax.
2. Fill any depressions or holes with a drywall compound
3. Use sandpaper to smooth any bumps and blemishes. Sand until the surface is completely flat.
4. Level-5 finish to the surface and apply one coat of acrylic based primer.

Commercial use recommendation

If you would like your screen to have a professional-grade finish that is flat, durable, and free from imperfections – EliteProAV strongly recommends hiring a professional wallpaper installer.

Glue Powder Compound Method for dry-wall (porous surfaces) installations

Installation

We strongly recommend three or more people for this installation.

1. Measure and draw a line around the screen installation area.

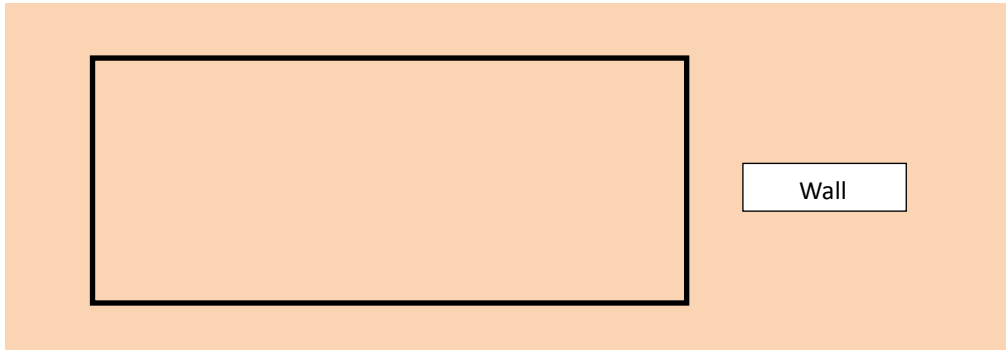

2. Apply one coat of **Professional R-35 Primer** and allow it to dry.
3. Un pack the Insta-DE 2a material from the box and lay it on a clean surface.
4. Scrape the installation area to assure a smooth surface. Sand as needed and clean dust with sponge.
5. Pour 25 oz. of room temperature water into a bucket, mix it with an entire glue powder bag and stir it with a whisk until all lumps are gone and the compound has a syrup texture. This will make the mixture into an adhesive compound for sticking the film to the wall.
Note: Once the compound has been mixed, it must be applied within 4 hours to ensure a sealed installation of the Insta-DE 2a to the wall. *Use one bag for every 25 oz. of water.*
6. Pour the mixed glue compound thru a strainer into a paint tray. This is to avoid using compound that has lumps which could result on the wall and causing bumps on the material.
7. Put a 3-4-inch piece of painter's tape on the outer edge markings of the screen's installation area. Space them out approximately 18 inches apart.
8. Dip the paint roller in the paint tray and evenly apply a thin coat of the glue compound to the wall surface in 5 feet increments.
Do not allow the glue to dry. Use a spray bottle to gently wet the dry areas.
9. Carefully place and align the **Insta-DE 2a** on the left-hand side of the installation area. Once it has been placed, peel off 18 inches of the back film to expose the self-adhesive backing and attach to the installation area.
10. Use the painter's tape that was put on the outer edge and tape the Insta-DE 2a to keep it from moving.
Note: The Insta-DE 2a material cannot be moved once attached, please make sure it is properly aligned on the marked position.
11. **Smoothing the Insta-DE 2a**
 - a) Start from the Right-Middle area of the Insta-DE2a.
 - b) Make sure the **Insta-DE2a** adheres properly to the wall before proceeding.
 - c) Continue scraping as needed in an up/down/left direction as shown in the picture below, Step-2, Step-3. Continue doing this until all material is attached.

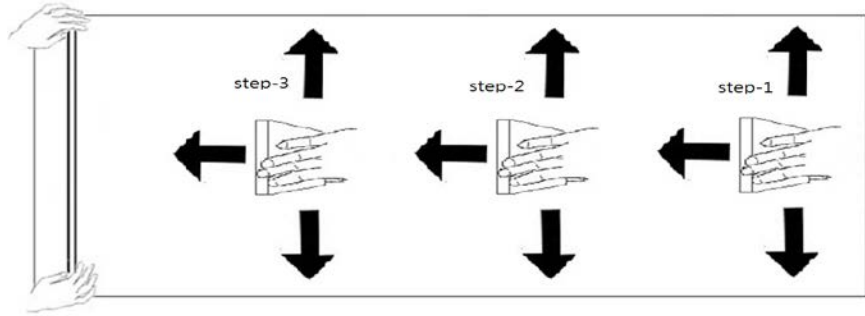

11. Final Inspection:

Flash a light source directly on the surface of the *Insta-DE2a* to help inspect for air bubbles or dust.

Note: The *Insta-DE2a* should not come off at this stage. If air bubbles are present, the only way to remove them is to smooth them out.

13. Adhesion curing time:

In order to allow the *Insta-DE2a* and wall to properly bond, please refrain from touching and using the dry-erase feature of the *Insta-DE2a* for a period of 2 days after the installation has been completed.

Self-adhesive Method for non-porous surfaces

1. Wall preparation:

Clean the entire non-porous surface with a wet sponge or a lint-free towel

2. Measure and draw a line around the screen installation area.

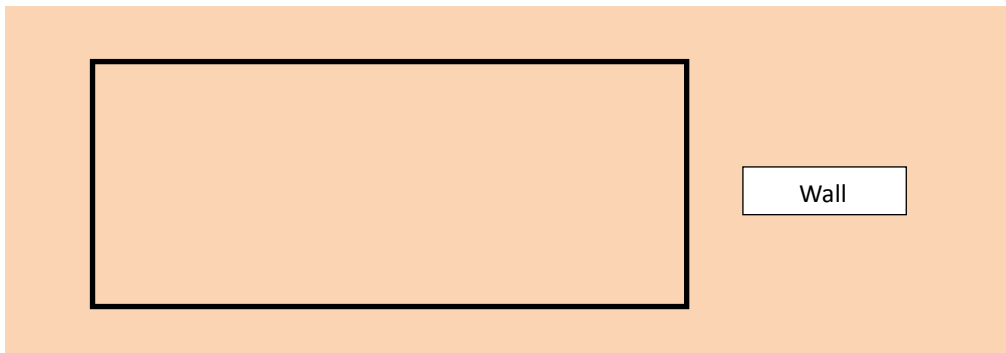

3. Moisturize the screen installation area:

a) Spray water on the screen installation area evenly with a sprayer.



b) Make sure the entire area where the *Insta-DE2a* will be installed is wet lightly (do not drench).

Note: The adhesive may not stick appropriately if the installation area is not sufficiently wet.

4. Procedures for attaching the material:

- a) Carefully place and align the *Insta-DE2a* on the right-hand side of the installation area. Once it has been placed, peel off 18 inches of the back film to expose the adhesive.
- b) Spray the adhesive area to allow the *Insta-DE2a* the ability to move within the wet installation area.
- c) Press the *Insta-DE2a* down with both hands to firmly position it in place.
- d) As one person holds the *Insta-DE2a* in place, the other person peels off the backing from right to left.
- e) Spray the exposed adhesive back of the *Insta-DE2a* and continue until the entire area is wet.
- f) The *Insta-DE2a* material at this point can be easily moved and adjusted within the installation area if needed.

5. Smoothing, scrapping out air bubbles and water:

Caution: The scraper's edge is sharp. Carefully scrape the screen in a 45 degrees angle when removing air bubbles to avoid scratching the surface.

- a) Start from the Right-Middle area of the *Insta-DE2a*. Scrape up/down/left to remove the air bubbles/water and dry any water excess with a lint-free cloth.

Note 1: Dust or other matter may reside within the *Insta-DE2a* and the wall. To remove such debris, simply peel back the *Insta-DE2a* from the wall and clean it with the mixture described in step 3-a.

- b) Make sure the *Insta-DE2a* adheres properly to the wall after cleaning before proceeding.
- c) Continue scraping as needed in an up/down/left direction as shown in the picture below, Step-2, Step-3.

Note 2: Occasionally, water may come back in the areas that were just scrapped out. To avoid this from happening, please make sure to dry any excess water immediately with a clean sponge or lint-free cloth as soon as water is squeezed out.

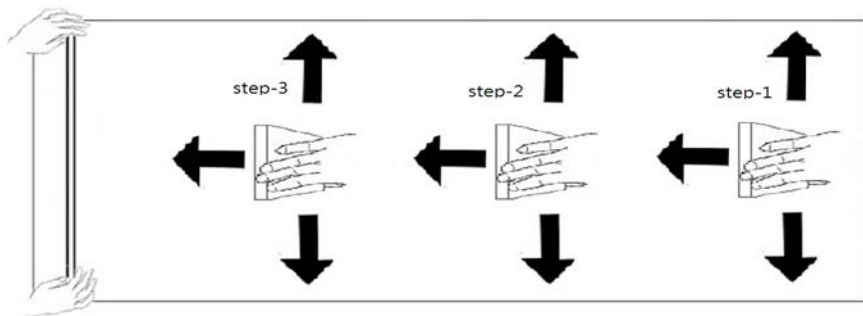

6. Final Inspection:

Flash a light source directly on the surface of the *Insta-DE2a* to help inspect for air bubbles or dust.

Note: The *Insta-DE2a* should not come off at this stage. If air bubbles are present, the only way to remove them is to use a scraper to squeeze them out.

7. Adhesion curing time:

- a) In order to allow the *Insta-DE2a* and wall to properly bond, please refrain from touching and using the dry-erase feature for a period of 2 days after the installation has been completed.
- b) It is normal for the surface of *Insta-DE2a* to have slight wavy edges. These will go away and flatten after 1-2 days.

Frame Border Installation

The circular labels on the vertical frame pieces indicate their proper position for completing the installation. Proceed with Step 1 to begin.

Attention:

Please be sure that the walls are clean and free of debris before installing the frame.

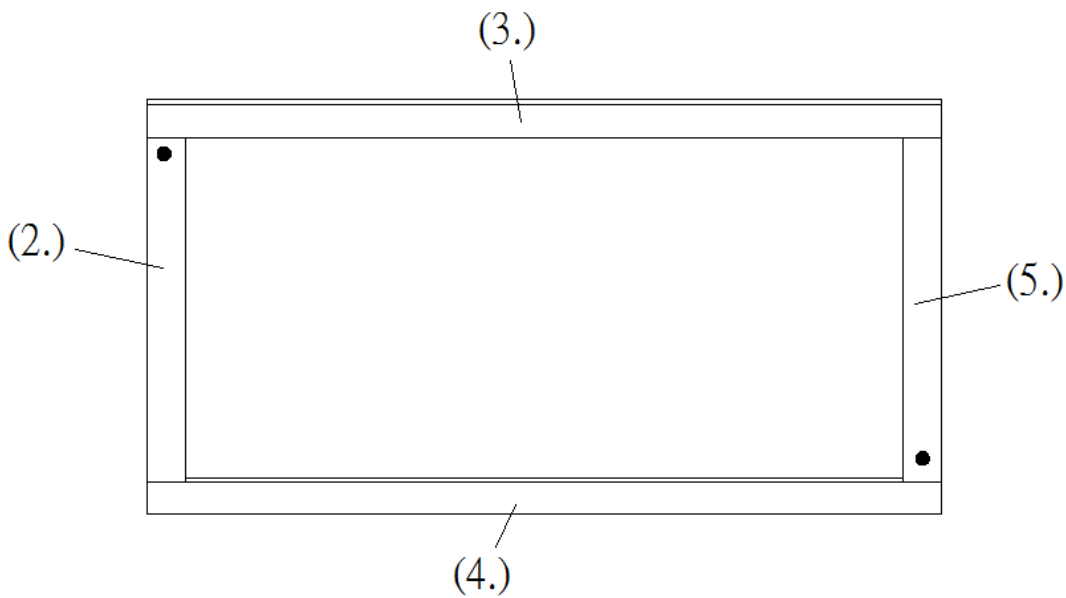
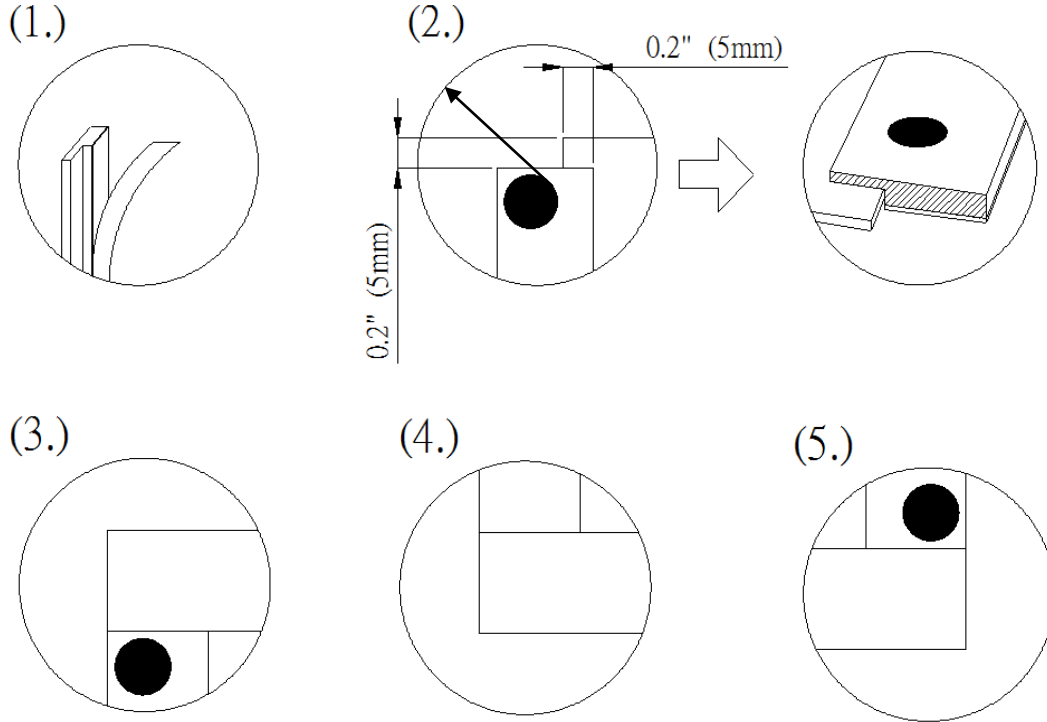

The following velvet border installation steps are intended for the Insta-DE 2a Series only.

Adhesive black velvet border installation

1. Measure the top/bottom and left/right sides of the Insta-DE2 screen to obtain the required length of the velvet border you will need to use for bordering your screen.
2. Peel a small portion off of the velvet border and place it about half an inch over the white area of the screen. Continue to peel off and roll out the remainder of the velvet border until you have reached the end and cut the edge.

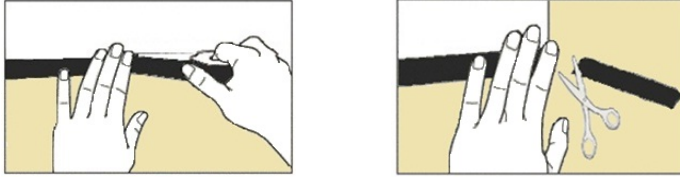

Note: For best results we recommend cutting the edge in a 45° angle.

3. Repeat the process for the remainder of the sides until all sides are bordered as shown below.



Tray Installation

1.

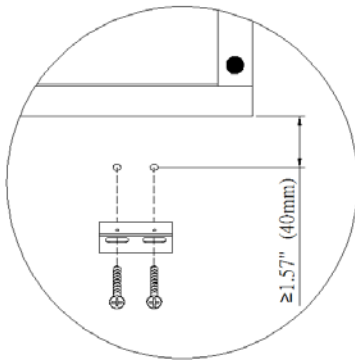

2.

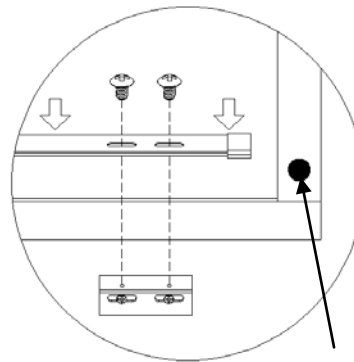

Remove both labels

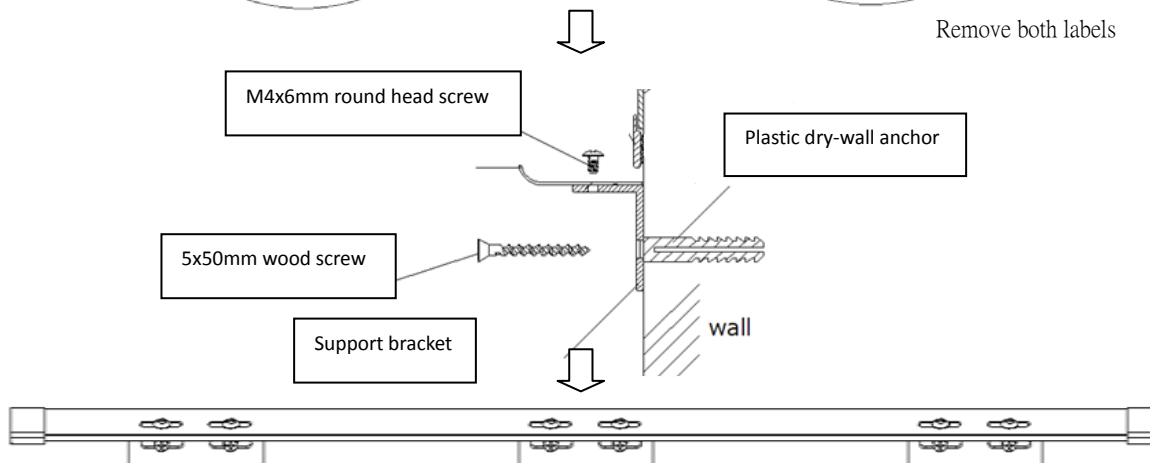

Attach the wall brackets to the wall and tray as shown above to complete your installation.

DIAGRAM OF FINISHED INSTALLATION

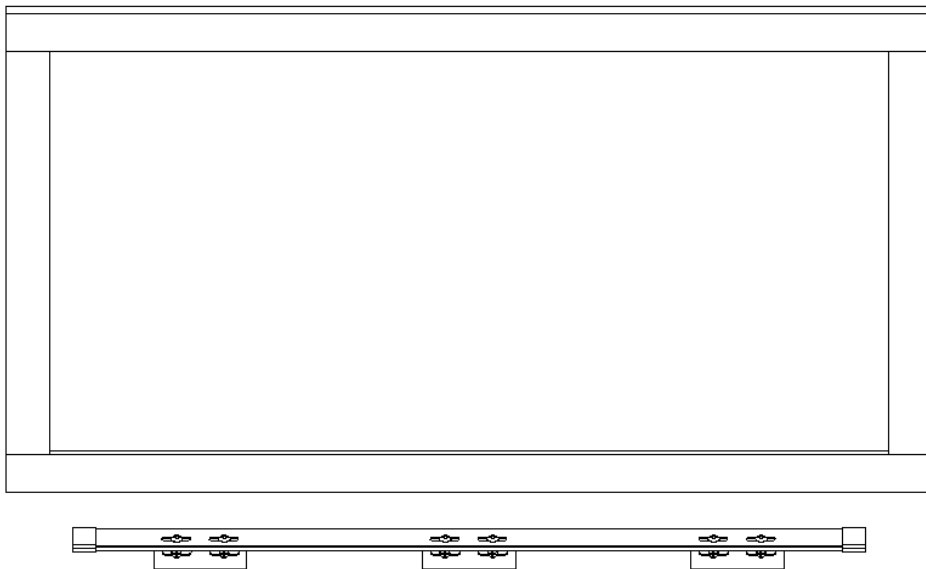

Use only the included erasers to remove and erase dry-erase markings. For a deep clean, we recommend using a non-alcohol based dry-erase board cleaner with a soft microfiber cloth.

Elite offers a replacement kit (**part number ZER3**) which includes:

- 1 x bottle of 8.45 oz cleaning solution
- 1 x microfiber cloth
- 2 x high density foam erasers
- 2 x sets of dry-erase markers (4 total)



Contact your reseller or visit shop.elitescreens.com for pricing and purchase.

Safety Precautions:

1. Avoid using sharp objects directly on the screen which can result in permanently damaging the product and voiding your warranty.
2. Creases or wrinkles caused by improper installation are not removable.

Please be advised:



The above picture is the result of an improper installation. The main factor that contribute to this should be avoided per the tips below.

- The surface to which you are installing this material to should be perfectly smooth. If in case the surface is uneven, it is recommended to place a smooth board over the desired space of the install first. This will eliminate any bubbling of the material over time.

Dimension Table

Insta-DE 2a Dimension Table

Model Number	Diag. Size	Aspect Ratio	View Area (HxW)	View Height (A)	View Width (B)	Thickness (C)
Unit: Inches						
IWB85SW2a	85"	1:1	60.3"x60.3"	60.3	60.3	0.0063
Unit: mm						
IWB85SW2a	85"	1:1	60.3"x60.3"	1531	1531	0.2

Note: Data Error $\pm 1"$

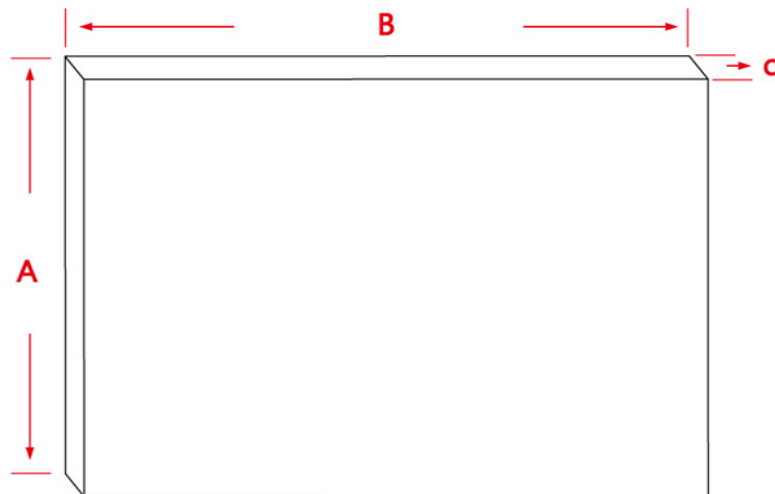

Insta-DE 2aF Dimension Table

Model	Diag. Size	Aspect Ratio	View Area (HxW)	View Height (A)	View Width (B)	Frame Height (A1)	Frame Width (B1)	Tray Width (B2)	D	D1
Unit: Inches										
IWB5X10W2AF	5'X10'	N/A	59.8"x119.6"	59.8	119.6	59.8	121.1	50.8	0.1	1.8
IWB5X20W2AF	5'X20'	N/A	59.8"x219.6"	59.8	219.6	59.8	221.1	50.8	0.1	1.8
IWB114XW2AF	114"	16:10	55.9"x99.4"	55.9	99.4	55.9	100.9	50.8	0.1	1.8
Unit: mm										
IWB5X10W2AF	5'X10'	N/A	59.8"x119.6"	1520	3038	1520	3076	1290	4	45
IWB5X20W2AF	5'X20'	N/A	59.8"x219.6"	1520	5578	1520	5616	1290	4	45
IWB114XW2AF	114"	16:10	55.9"x99.4"	1419	2523	1419	2563	1290	4	45

Note: Data Error ± 1 "

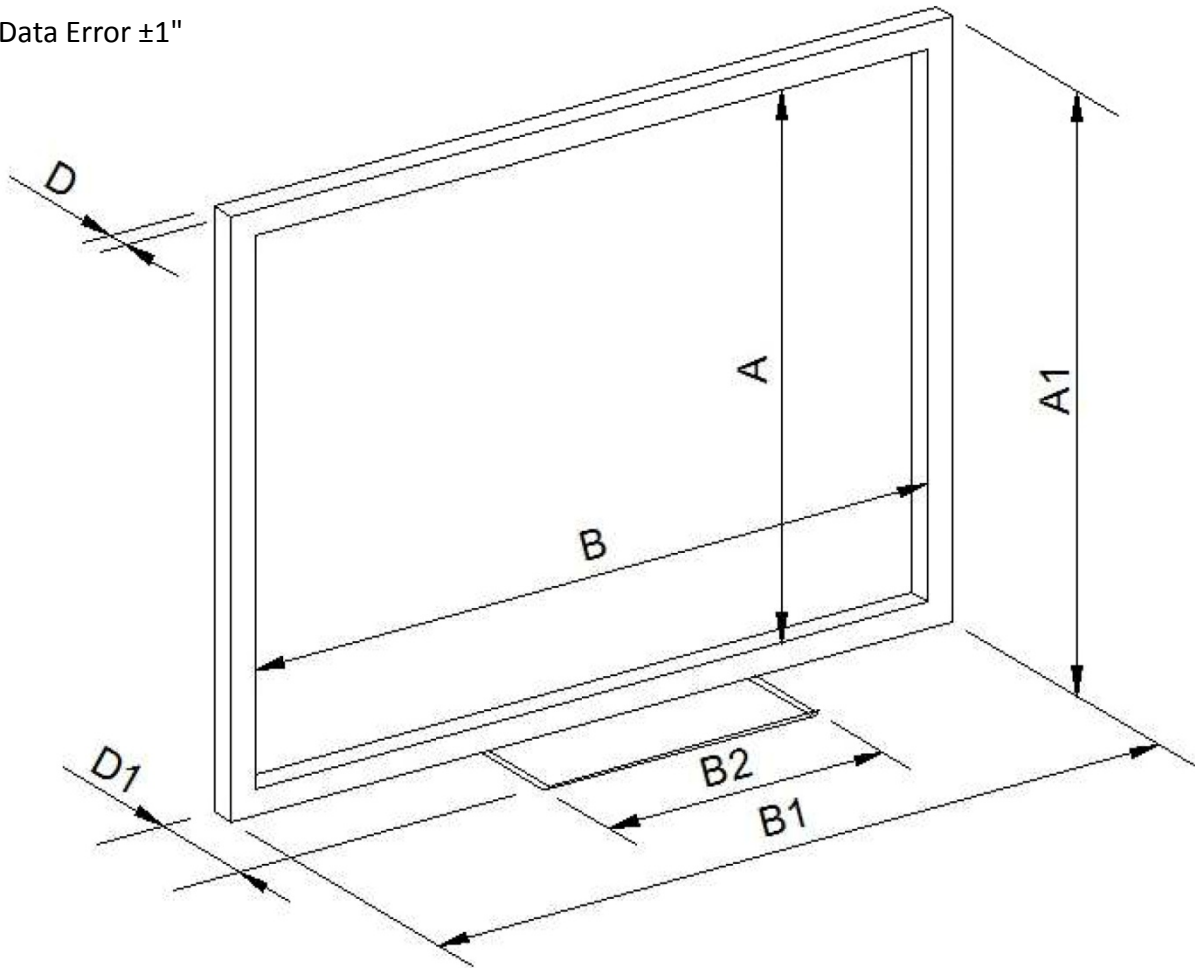

For more information, technical support or your local EliteProAV contact, please visit www.eliteproav.com