



Electric Wall/Ceiling Projection Screen

Saker Tab-Tension Series

User's Guide – E Type (RC1)

Important Safety & Warning Precautions

Make sure to read this user's guide and follow the procedures below.

Caution: The screen's Black Top Drop is already set to its maximum drop distance. There is NO extra Black Top Drop in the roller. Please be aware of this as it will void your warranty with Elite ProAV™. Unapproved changes or modifications (except for cutting the power cord for hardwire installations) to this unit are prohibited and will void your warranty.

- Please retain this user's guide for future reference.
- To avoid damaging the unit, do not use with any unauthorized accessories not recommended by the manufacturer.
- Handle the unit carefully during transportation to avoid any damages.
- To ensure safe and reliable operation, direct connection to a properly grounded power source is advised.
- The power outlet supplying power to the unit should be close to the unit and easily accessible.
- Do not install the unit on uneven or inclined surfaces.
- Do not put heavy objects on the power cord and position it properly to avoid creating a trip obstacle.
- Never overload the power cord to prevent an electric shock or fire due to a loose contact or a short circuit.
- There are not user serviceable parts in this unit. Do not attempt to disassemble this unit by yourself. No one except authorized technicians can open and make repairs to this unit.
- Make sure the power source this unit is connected to has a continuous power flow.
- If there is need to use an extension cord, make sure the cord has an equal rating as the appliance to avoid overheat.
- Do not handle the power plug when your hands are wet or your feet are in contact with water.

Do not use this unit under the following circumstances.

- Disconnect the power cord under the conditions of heavy rain, wind, thunder or lightning.
- Avoid direct Sunshine, rain shower and moisture.
- Keep away from fire sources and high temperature to prevent this device from overheating.
- Cut off the power supply first before transportation or maintenance.
- Fully disconnect from the power supply when the unit is not in use for a long period of time, as should be done with any other electric household appliance.
- To avoid possible injury and/or an electric shock, do not attempt to use the screen if there is obvious damage or if there are any evident broken parts.

WARNING

The Screen's **Top Black Drop** is already set to its maximum drop distance. There is **NO** extra top black drop in the roller. Please be aware of this as it will void the limitation of your warranty.

Individual modifications to this product are prohibited and will void the warranty with the manufacturer. Please contact EliteProAV™ Customer Service for any questions.

NOTE: This equipment has been tested and found to comply with the limits for a Class B digital device, pursuant to Part 15 of the FCC Rules.

These limits are designed to provide reasonable protection against harmful interference in a residential installation. This equipment generates and can radiate radio frequency energy and, if not installed and used in accordance with the instructions, may cause harmful interference to radio communications.

However, there is no guarantee that the interference will not occur on a particular installation. If this equipment causes harmful interference to radio or television reception, which can be determined by turning the equipment off and on, the user is encouraged to try to correct the interference by one or more of the following measures.

- ✓ **Reorient or relocate the receiving antenna of the device which may cause interference.**
- ✓ **Increase the separation between the screen and the device's receiver.**
- ✓ **Connect the equipment into a different power outlet other than the device.**

Pre-Installation





1. Carefully unpack the screen.
2. Always handle the screen in a leveled position on a clean surface.
3. In order to protect the screen from exposure to stains, keep the screen out of contact with foreign particles such as dust, sawdust, and/or liquids.

NOTE

Regardless of the mounting method, the screen should be securely supported so that the vibration or pulling on the viewing surface will not cause the casing to become loose or fall. The installer must ensure that the fasteners used are of adequate strength and suitable for the installation location. Included mounting screws are complimentary and may not be appropriate for all mounting surfaces. Use appropriate anchors to safely secure the screen to the mounting surface or consult with a professional installer.

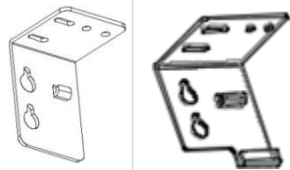
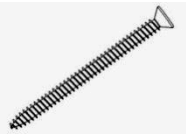
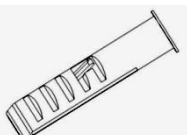
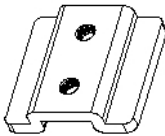
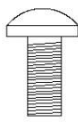
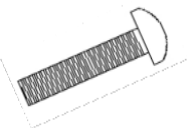
Hardware Parts List

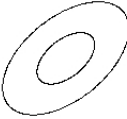
Please make sure all parts listed below are included before proceeding with the installation.

A. Wall/Ceiling mount bracket x2	B. M5x60 Screw x4	C. M12 Dry-wall anchor x4	D. Bracket connector x2	E. M5x11 Bolt Screw x4
 For 135" below For 135"-180"				
F. M5x25MM round head cross screws x2	G. M5x30MM eyebolt screw & M5 nut x2	H. Hidden wall bracket x2	I. R18xR6x1 washer x4	J. Snap link x2
				

Installation Instructions

For installation assistance, please consult a professional Installer. EliteProAV™ is not liable for faulty installations.

A. Wall Mount

I. Flush mount with wall/ceiling brackets (fixed position)

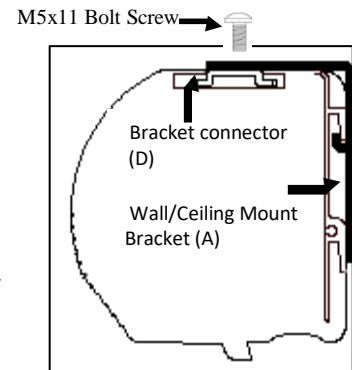
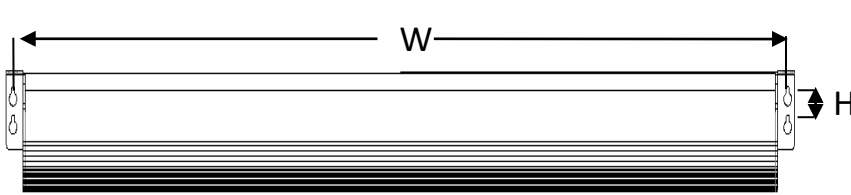

1. Begin by sliding the **bracket connector** (D) all the way to each end of the housing.
2. Then attach it to the **wall/ceiling mount bracket** (A) with the **M5x11 bolt screw** (E).
3. Measure and mark the (WxH) distance between the two holes on each bracket.
4. Drill a hole for each screw hole on the marked areas.
5. Insert a **dry-wall anchor** (C) into the wall.
6. Insert a **M5x60 Screw** (B) in each **dry-wall anchor** (C) and screw it in leaving about 1/8" of an inch.
7. Hang the screen by aligning the end cap holes to the **M5x60 screws** (B).

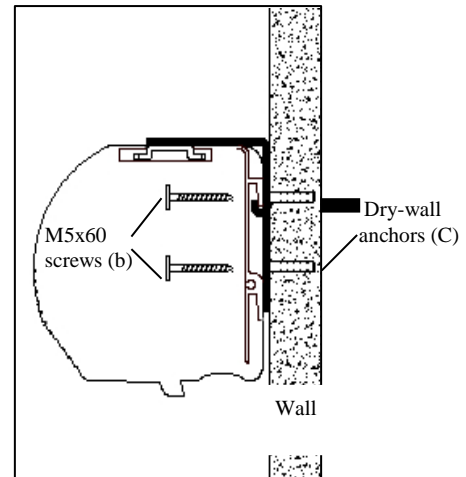
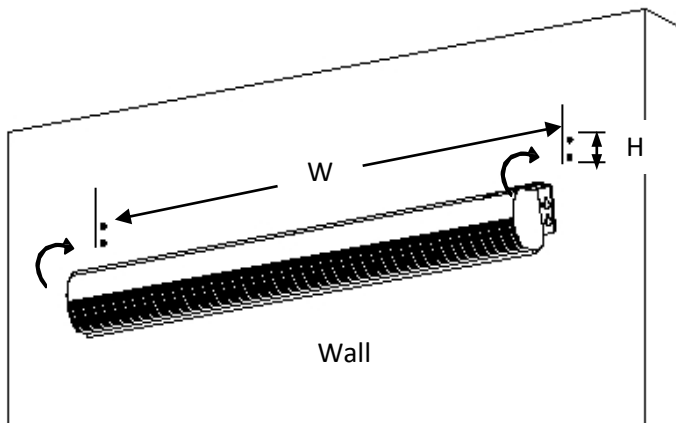

II. Flush hidden mount (movable position)

This mount method allows the screen to slide horizontally.

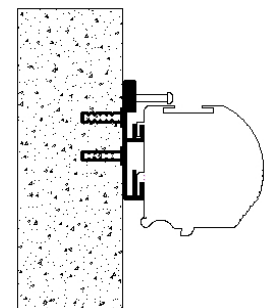
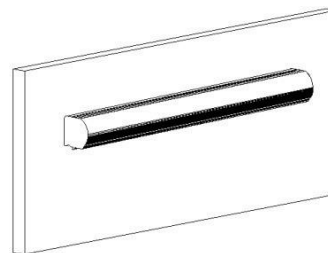
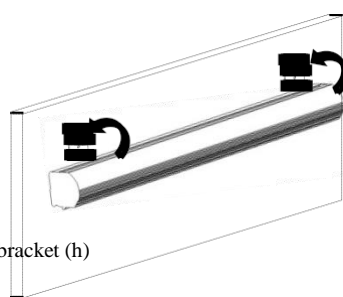
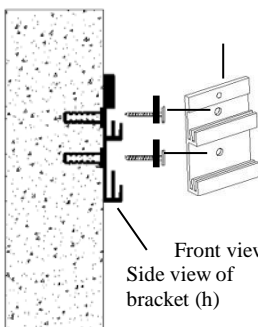

1. Determine where the screen will be installed. Then, measure and mark the distance between the top and bottom screw holes from each **hidden wall mount bracket** (H).
2. Drill a hole on all marked areas and install the brackets with the **dry-wall anchor** (C), **M5x60 screw** (B), and a **washer** (I). Make sure both brackets are properly leveled.
3. Hang the screen by placing the **downward** "catch" located on the back over the brackets **upper** "catch".
4. After making sure the screen is secured, you can slide it left / right to properly center it in position.
5. Lastly, screw the **M5 screw** (F) into the upper hole of the bracket to add additional support for the screen.

B. Ceiling Mount

I. Ceiling Mount (fixed position on end caps)

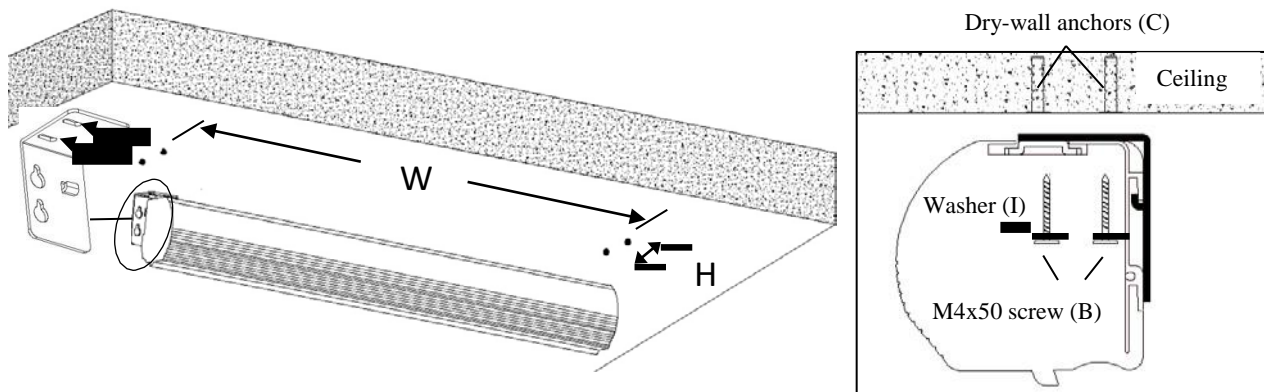

NOTE: The brackets do not slide. They are designed to attach the end caps only.

1. Attach the *Wall/Ceiling mount bracket (A)* to the *Bracket connector (D)* located on top of the screen's housing (preinstalled).
2. Determine where the screen will be installed. Then, measure and mark the distance between the (WxH) locations.
3. Drill a hole on all marked areas and insert a *dry-wall anchor (C)*.
4. Secure the screen by inserting the *M5x60 screw (B)* and a *washer (I)* thru the *wall/ceiling mount brackets (A)*.
Two or more people are required while one holds the screen in place.

II. Suspended

1. Screw the *eyebolt (G)* on the *bracket connector (D)*.
2. Attach the *snap link (J)* through the *eyebolt (G)* and connect it to an eyebolt screw (not included) rated for the screen's weight.

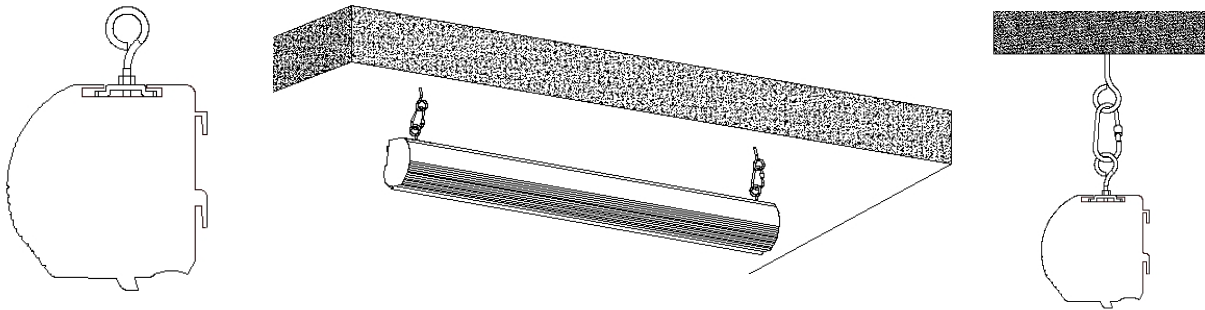

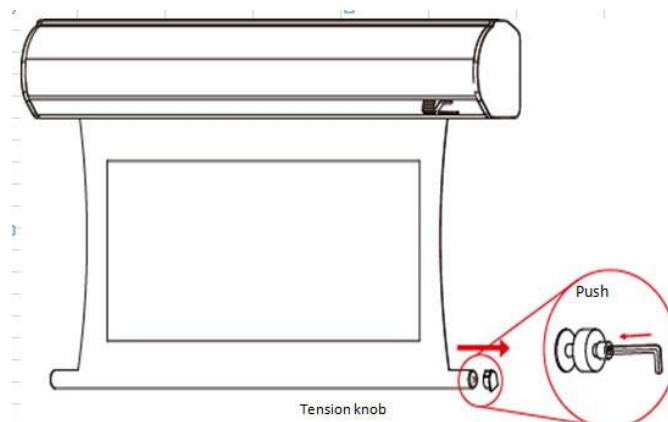

Screen material tension adjustment (4mm Allen Wrench required and not included)

Remove the weight bar end cap to expose the adjustment tension knob. Insert your 4mm Allen Wrench to push in the adjustment tension knob, turn clockwise and your screen will gain more tension. Turn the Allen Wrench counter clockwise and the screen will lose tension. Please note this adjustment is not necessary as the tension of the screen has been set to its factory setting for best performance. Please contact EliteProAV™ for assistance to avoid damaging the screen and voiding your warranty.

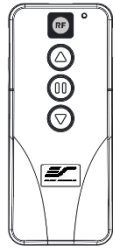
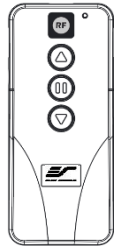
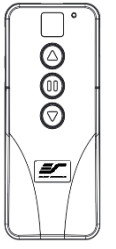
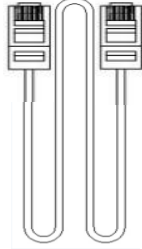
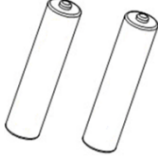

Saker Tab-Tension | Controls and Accessories

A. IR Remote ZRC1-IR	B. RF Remote ZRC1-RF	C. Wall box controller ZRC1-WB	D. RJ50 cable ZRC1-RJ50	G. AAA batteries	H. Bubble leveler
					

Screen operation

Electric Current: 110v.

1. After ensuring the power outlet & screen are compatible (voltage), plug the power cord into the power outlet.
2. Once the screen has power, you'll be able to control it using any of the 6 methods described below.

5 Ways to control your screen

1. IR Remote control (Item A, Fig 1): The Infrared functions by direct line of sight contact using an effective beam range of 25 feet within a 30-degree angle. Aim the IR remote directly at either the IR receiver on the Wall Box Controller or on the screen to operate the screen.

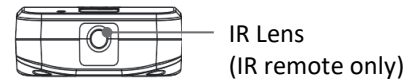

Note: Assure there is no obstruction between the IR remote and IR receiver.

2. RF Remote Control (Item B): The radio waves eliminate the need for a direct line of sight and has a longer distance control range.

The RF remote is already pre-synced/paired and ready to use. If synchronization/ pairing is needed, please follow the steps below.

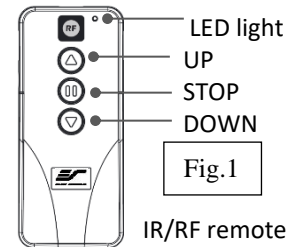

How to synchronize/pair a new RF remote:

- Press & hold the “**Programming Key**”, then press the “**Up Key**” on the **Wall box controller** (wall-box LED flashes). *Reference the wall box controller section for programming key location.*
- Then press the “**Up Key**” on the **RF remote**.
- The **Wall box** LED will flash 5 times, to indicate the RF remote has been properly synchronized/paired.

How to change the RF code (For use when multiple screens/RF remotes are owned)

Changing the RF code avoids controlling multiple screens at the same time and prevents electrical interference leading to accidental control of the screen.

1. Remove the batteries
2. Change the RF code switch
3. Insert the batteries
4. Synchronize it with the wall box controller

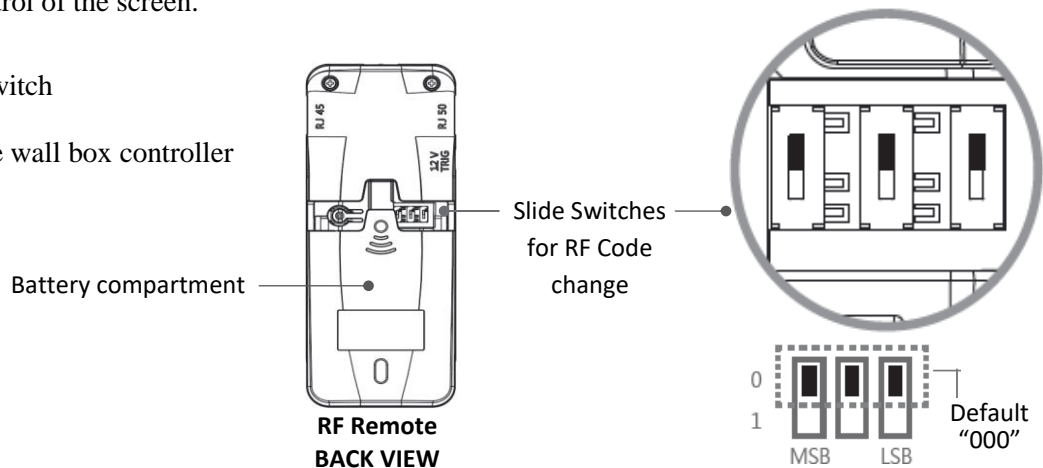

3. **Wall box controller (Item C, Fig 3):** The wall box controller switch is a wall mounted control box with an up/stop/down button. It plugs directly into the screen's RJ50 port.

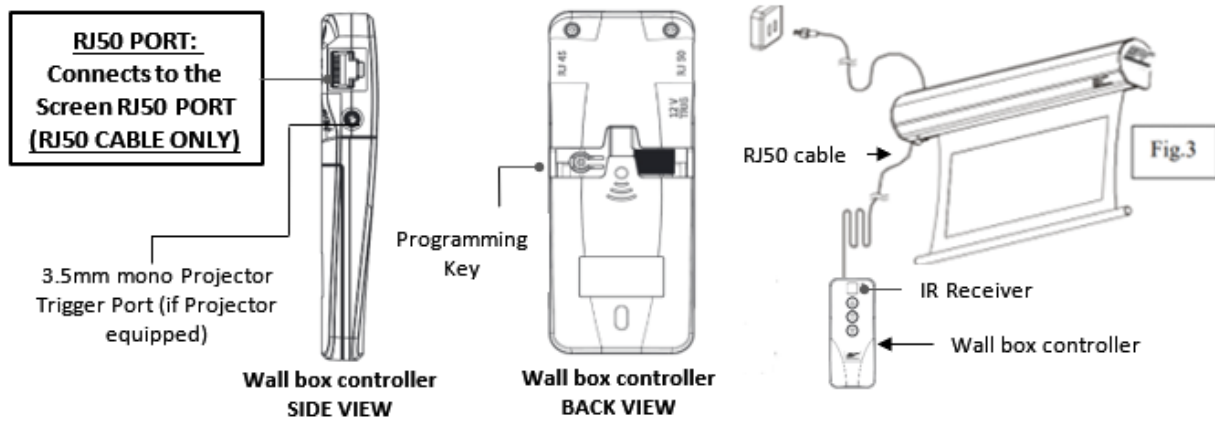

4. **Wired 5-12 volt trigger:** Requires a 3.5mm to 3.5mm mono cable (not included)

Step 1: Connect one end the RJ50 cable to the screen and the other end to the Wall box controller.

Step 2: Then connect one end the 3.5mm mono cable to the wall box controller and the other to the projector.

Once the two cables have been connected, the wired trigger feature is ready to synchronize the screen's up/down operation with the projector's power cycle.

- Projector on, screen drops
- Projector off, screen raises

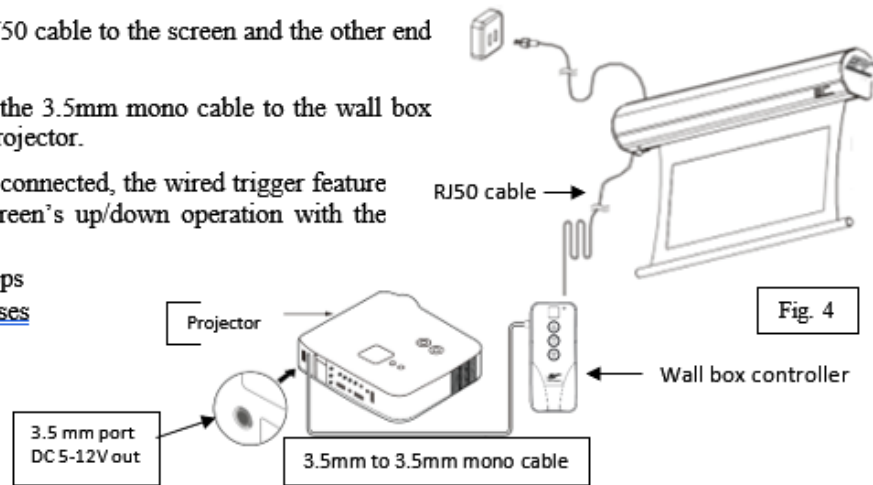

5. **Wireless 5-12 volt trigger (Fig 5):** Requires a 3.5mm to 3.5mm mono cable (not included).

The Radio Frequency (RF) remote control serves as a dual purpose, independently as a handheld remote control, or as a Wireless 5-12 volt trigger. The radio frequency technology sends a wireless signal that synchronizes the screen's drop & rise with the projector's power cycle.

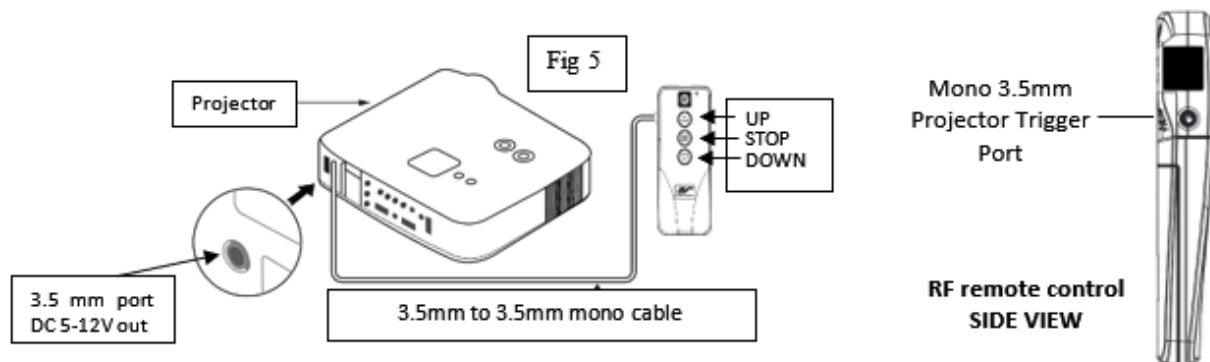

Here's how to set up your Wireless 5-12 volt trigger

The 5-12V wireless trigger should already be synced and ready to work.

Step1: Connect one end of the 3.5 mm mono trigger cable to the RF remote.



Step 2: Connect the other 3.5 mm mono end of the cable to your projector



Step 3: Turn on the projector and the screen should automatically deploy.

Step 4: Turn off your projector and the screen should automatically retract.

(Please be aware, the projector on/off cycle may take longer to fully activate. It usually takes around 20- 30seconds for full off and on cycle each time)

Note: If the wireless trigger feature does not work, please resync the RF remote to the Wall box controller per the instructions in the Radio Frequency remote section.

ADVANCED Programming Key Instructions: (FOR ADVANCED USERS ONLY)

* Wall box controller must be connected to the screen.

ATTENTION: Reducing the factory's full screen drop may produce waves/wrinkles on the projection surface on tab-tension screens. The full drop is recommended to allow the screen to rely on the tab-tension system to maintain the projection surface flat and taut on all sides.

The same applies on non-tensioned screens, although some level of waves may be present due to the nature of the screen not being tensioned. If wrinkles/waves develop after making the adjustment to the desired drop position, reset it to the factory's default position per the instructions below.

FLATNESS AFFECTED BY NEW PROGRAMMED VERTICAL POSITION IS NOT COVERED UNDER A REPLACEMENT WARRANTY.

1. Preset the Screen's Drop Position:

Use the RF/IR remote or Wall Box Controller to Drop the screen to the desired position you want to set it at. Press & hold the "**Programming Key**", then press the "**Down key**" on the Wall Box Controller. The LED will flash 5 times to confirm new programmed drop position.

PROGRAMMING NOTE:

The programmed vertical position relies on a time-count which adjusts itself according to the programmed timed difference. Multiple up/down programming will result in the vertical position being off a few inches. It is recommended that programming is done the **first-time** the desired vertical position is determined or RESET it to factory default and programming the desired vertical position afterwards.

2. Clear/Reset the Screen's Drop Position to factory default:

Press & hold the "**Programming Key** + "**Stop key**" on the wall box controller.

For more information, technical support or your local EliteProAV™ contact, please visit www.eliteproav.com